

Camfil CamContain GB Series Housings are designed for use in critical processes where hazardous airborne materials must be prevented from escaping the air filtration system. Air filters may be replaced using a control barrier to protect change-out personnel from contaminants within the housing or spent filters.

The CamContain GB Housing minimizes exposure to harmful contaminants during filter service through the use of a PVC bag enclosure system. The entire filter changing process isolates personnel from the hazardous materials.

The Camfil GB's standard configuration may be customized with various options specific to the application.

These housings are typically used in facilities where hazardous materials are encountered. These contaminants may include biomedical, radiological, carcinogenic or other materials of concern.

Some specific applications include:

- Chemical manufacturing facilities
- Food processing
- Genetic research and biotechnology facilities
- Hospital Isolation Suites to prevent the spread of infectious diseases
- Industrial processes exhaust
- Microelectronic and semiconductor facilities
- Nuclear power plants
- Pharmaceutical facilities
- Radioisotope handling facilities
- University research laboratories
- US Department of Energy Facilities
- Veterinary research and animal disease laboratories
- Government and military facilities.

1400 pounds of gasket-sealing integrity ensure complete capture of airborne contaminants

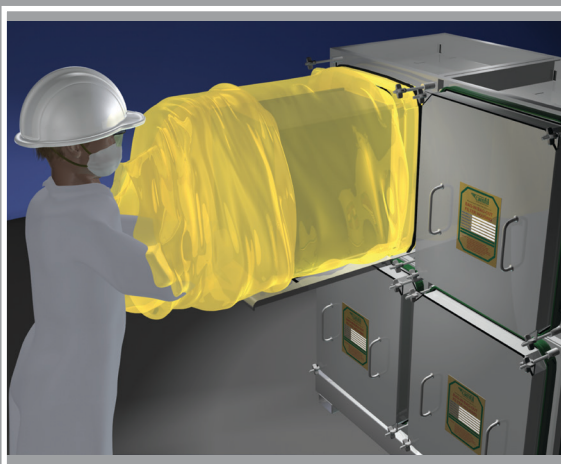

The highest level of personnel protection.



Figure 2

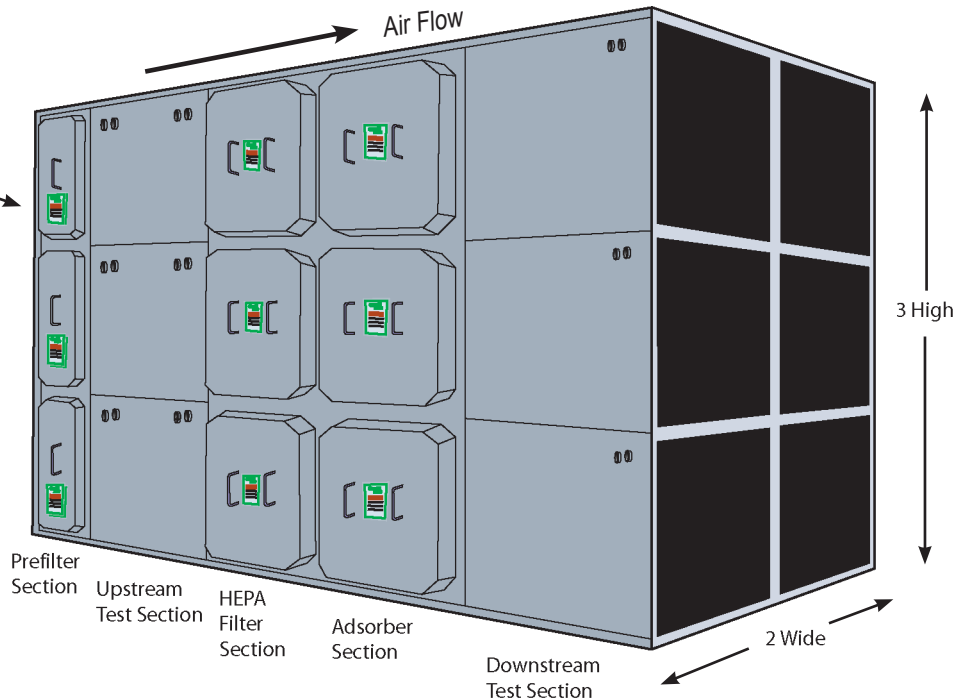

Figure 1

CamContain GB Housings are available in configurations from ½ x ½ (one filter 12” by 12” size) to configurations that are 1 filter high x 3 filters wide that allow the service of up to three 24” by 24” filters from a single service door.

Units may be stacked or connected in series depending upon the airflow requirements and contaminants of concern. The housing in Figure 1 shows a stacked unit that is 3 filters high by 2 filters wide and includes 3 stages of air filtration.

In many cases, air filtration standards are required by Federal or State mandates or by recommended practices by other cognizant authorities. Every unit clearly identifies specific equipment details on a stainless steel label (Figure 2). The following components assure compliance with these mandates.

Prefiltration

CamContain GB Housings can incorporate a prefilter track to extend the life of the primary filters. Tracks may accommodate 2”, 4”, or 6” deep prefilters. Access to prefiltration may be through the same door as the final filter without disturbing final filter integrity. A separate door may also be provided for prefilter access only. Prefiltration efficiency typically ranges from a MERV 7 to a MERV 14 when evaluated under ASHRAE Filter Testing Standard 52.2.

Particulate Filters

Typically the primary filter in a containment system is a high efficiency particulate air (HEPA) filter. Camfil Absolute® (HEPA) filters are manufactured under strict quality control guidelines. Every filter is tested to ensure that the

particulate efficiency meets or exceeds the requirements of the application. Particulate filters are available from 99.97% on particles 0.3 micron in size to 99.9995% on particles 0.12 micron in size. All Camfil HEPA filters include a unique poured-in-place seamless gasket for superior filter sealing integrity. Conventional closed-cell neoprene gaskets are also available.

Standard Component Construction

Stainless Steel Construction

Camfil GB Housings are completely factory assembled and constructed of 11 and 14 gauge, 304/L and 316/L stainless steel sheet metal options. There are no painted surfaces, nor use of carbon/mild steel materials. Each housing is warranted to withstand 15” w.g. positive or negative pressure without failure of the housing to ambient air seal or compromise of the overall housing integrity. Each housing is tested to this level and test reports are available on request.

Camfil has the ability to custom design housing integrity to most operating conditions. Consult the factory for specifications related to your application or other non-listed material component needs.

Removable Star-Style Door Knobs

Each door is secured through the use of four threaded studs with removable star knobs. After filter change the knobs are tightened in an alternating pattern to ensure an even and secure housing seal.



Access Door(s)

Access doors, of the same construction materials as the housing, include a built-in bagging ring cavity to store the filter change bag during system operation. Each access door includes a high-memory silicone gasket that recreates a positive housing to ambient seal after each filter change. Convenient door handles are optimally placed so the doors have a natural balance during filter change.

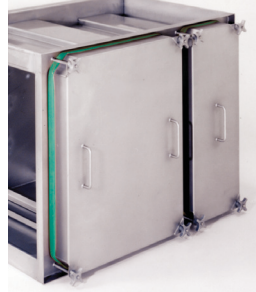

Dual Ribbed Bagging Rings

Each filter access port includes a ribbed bagging ring assembly for attachment of an 8-mil changing bag of polyvinyl chloride (PVC) construction. The bagging ring is continuously welded and hemmed to prevent damage to the bag.



Filter-Sealing Assembly

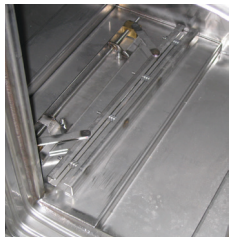

CamContain GB Housings incorporate a linkage clamping mechanism that may be operated with a standard wrench from outside of the housing.

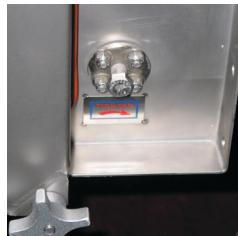

Filter seal adjustment is accomplished by a clearly identified hexagonal clamping bolt. Up to 1400 pounds per filter seal are applied. Filter change is then performed from inside the filter change out bag.

Banding Kit



The Camfil Banding Kit includes a case/lap apron, a heavy duty tie-banding gun, PVC bag cutting shears, a 7" hook-and-loop fastener cinching strap and ten 100-lb

tensile strength banding ties. Consult Camfil Bulletin 3410.

Dampers

Dampers allow isolation of components during filter change or decontamination processes. Camfil manufacturers low-leakage and bubble-tight designs. Pneumatic and electric options are available. Consult Camfil Bulletin 3440.

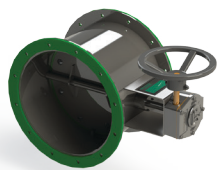

Decontamination Ports

Camfil can provide decontamination ports for the injection of materials designed to force neutralization of contaminants. This photo shows plug sitting on top of the port assembly. Plug type is ring-seal positive.



DOP/Freon Test Ports

To facilitate in-place filter evaluation Camfil can supply integral tests ports for the sampling of the challenge aerosol.

Drilled Flanges

Camfil can provide pre-drilled duct connection flanges. Holes are typically 7/16" in diameter with spacing not to exceed 4" (per DOE-HDBK-1169-2003 "Nuclear Air Cleaning Handbook 4.4.14"). For a bolt hole drawing of your housing model, please consult the factory.

Filter Change-out Shelf

A filter change-out tray provides support for the filters during the service process. Connecting conveniently to the door latches it can support filters and bagging components up to 300-lbs. Filter change-out trays are highly recommended for housing applications where ladders may be required for service or housings are in a difficult-to-reach location, or where heavy carbon adsorbers may be applied. Consult Camfil Bulletin 3410.

Lifting Lugs

Camfil can provide lifting lugs for unit transport and support during installation. The lugs are of 1/4" thick 304/L stainless steel and have a pre-drilled 2" hole. Common lifting lug locations include the top or side of the housing.

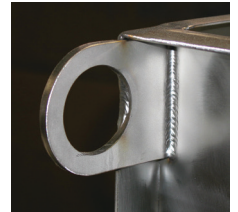

Plenums & Transitions

Camfil can manufacture all components required for complete system integrity. Matching plenums of the same construction as the housing are available to mate with existing equipment or ductwork. Transitions are also available to mate to equipment offsets.

Prefilter Housings

Camfil can provide housings with integral prefilter sections for application of 2", 4", or 6" deep prefilters. Various prefilter configurations are available. Consult Camfil Bulletin 3403.



Pressure Gages

Camfil can provide factory-mounted differential pressure gages to evaluate resistance across individual filters or any combination of internal components. Gage connections include copper tubing and brass fittings. Stainless steel tubing and fittings are also available.

Pressure Taps (static)

Static pressure taps are available to facilitate the connection of gages or other ancillary equipment. For on-site application of gages, taps include a removable brass or stainless steel plug.

Security & Cinching Straps

Replacement straps are available. Consult Camfil Bulletin 3410.

Swivel Door Latches

Camfil housings are available with swivel door latches to allow the latches to swing away from the filter change opening. Door latch components are captive as a precaution against dropping or losing them. Swivel door latches are highly recommended for housing applications where ladders may be required for service, or housings that are in a difficult-to-reach location.

Test Sections (in-place)

Test sections allow evaluation of filters without the on-site inline space penalties associated with the proper mixing of aerosol challenges. Standard test sections allow evaluation of an entire bank of filters. Scan test sections allow evaluation of individual filters to ensure that an individual filter does not have any leaks. All testing is accomplished without exposing the service personnel to contaminants contained by the housing. Consult Camfil Bulletin 3407-0902 for standard test sections and scan test sections.



Additional Options

Contact Sales-WA@camfil.com for factory consultation.

Casters

Camfil CamContain Housings may be mobilized with casters to allow use of the units in alternate locations.

Certified Weld Inspection (CWI)

Visual weld inspection can be performed by a certified weld inspector qualified to Section 6.1 of the American Welding Society Standards For Qualification and Certification of Welding Inspections, QC1-96. The inspections will be performed under the guidelines of AWS D9.1M/D9.1.

Flanges

Quarter-inch thick stainless steel plate flanges are available. The flanges can be furnished with 7/16" diameter holes no more than 4" on center as recommended in DOE-HDBK-1169-2003 "Nuclear Air Cleaning Handbook 4.4.14", or to mate-up with standard pipe flange bolt hole patterns. Standard raised-face, slip-on, stainless steel flanges per ANSI/ASME B16.5 are also available.

Deformation Testing

Non-destructive deformation testing is available. This test confirms systems will not deform at higher pressures.

Dye Penetrate Testing

Dye penetrate testing is available.

Electric Heaters

Electric heaters with pre-wired connection boxes are available.

High/Low Pressure Options

Camfil can assemble components to meet the pressure requirements of most applications.

High-Temperature Construction

Camfil housings are available with construction components that can accommodate process air to 450° F (232° C).

Humidifiers

Humidifiers are available to meet specific application needs.

Insulation

Housings may be insulated. All insulation incorporates double-wall housing construction.

Low Leak Testing

Low-leak testing to lower than standard leak rates is available.

Metal Door Pocket

A metal door pocket to store Operations & Maintenance Manual (O & M) during system operation is available.

Moisture Removal Drains & Valves

Moisture removal drains and valves are available. These are typically applied in installations that have concerns with regard to condensation, or if moisture separators are used in the system.

Moisture Separators

Moisture separators applied as prefiltration are available. Camfil ECO Moisture Separators have an efficiency of 98% on 5-micron size droplets. Other variations of moisture separators are available (consult factory).

Mounting Bases

Custom mounting bases are available. These are applied for seismic security or to match a roof curb.

Mounted Fans/Controls

Camfil will assemble complete trains of containment that can include particulate filtration, gaseous filtration and ancillary components such as fans and controls.

Seismic Qualification

CamContain GB Housings can be purchased with a special seismic certification in accordance with the criteria of the International Building Code (IBC 2015) and/or California Building Code (CBC 2016). Multiple module systems consisting of filter housings, test sections, dampers, etc. can be certified per application to meet most levels of severe seismic requirements. The current maximum code required seismic certification level is a Component Importance Factor $I_p=1.5$, Short Period Design Acceleration $S_d=2.0g$, and Height Ratio $z/h=1.0$ (roof level mounted). Additional information to provide assurance of special seismic certification requires factory consultation.

For nuclear projects, seismic qualifications per IEEE 344 is available via analysis and/or seismic testing under ASME NQA-1 Quality Assurance program for both structural integrity and anchorage and functionality requirements. Consult factory for project purchase specification and seismic requirements specification.

The Complete System

Camfil manufactures all of the components that may be required in a containment train of housings. From the filter, to the bag, to the dampers that isolate the system, quality is assured through unparalleled component compatibility. Performance and protection from one source, Camfil, a worldwide leader in air filtration technology and production.

Quality Assurance

Camfil has quality control initiatives that ensure our products meet or exceed industry standards set forth by cognizant authorities, including the United States Government. These programs are inclusive of raw materials acquisition, procedures of transport and storage, preparation and assembly of these materials to a final product form, and the testing and qualification.

Camfil Safety and Protection production facilities have been audited by various entities and found to be acceptable. These procedures are part of a living doctrine that is updated based upon improved technologies and the increased needs of the applications. Camfil containment products are manufactured under a Camfil Quality Assurance program, including the basic requirements of ASME NQA-1 when specified.

Camfil Absolute filters and ASHRAE grade filters that may be used in containment applications are manufactured in ISO 9001:2001 facilities. Camfil Nuclear Grade Absolute filters complying with the requirements of Section FC of ASME AG-1, are manufactured under an ASME NQA-1 Quality Assurance Program.

Additional quality assurance procedures are in place to meet the needs of specific end users. These procedures are available for review and modification by end users, our authorized representatives, and Camfil.

Contact the factory at Sales-WA@camfil.com for additional information.



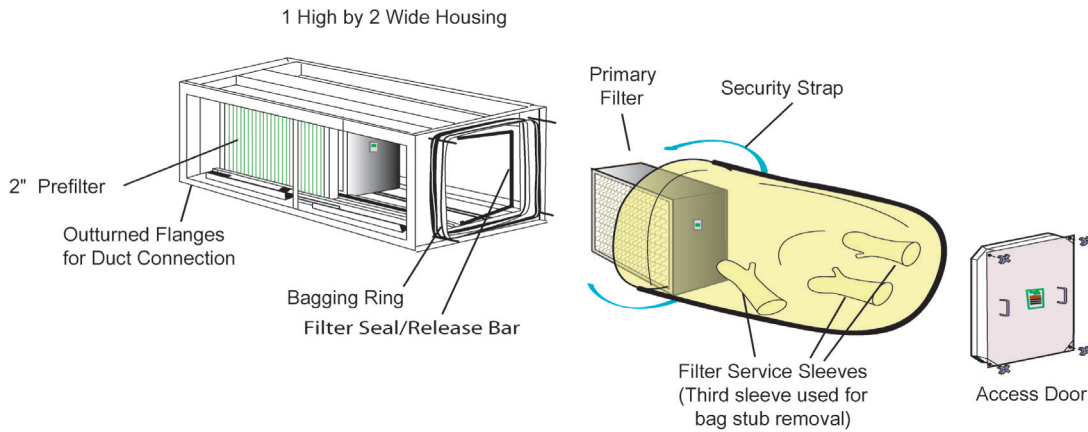

CamContain Housings are designed with safety in mind. Each housing is shipped with an instruction book detailing how to change the filters. The basics of filter change include installing the new filters in the change-out bag, securing the bag over the ribbed openings on the housing door opening, and performing the filter change entirely within the bag.

STEP 1

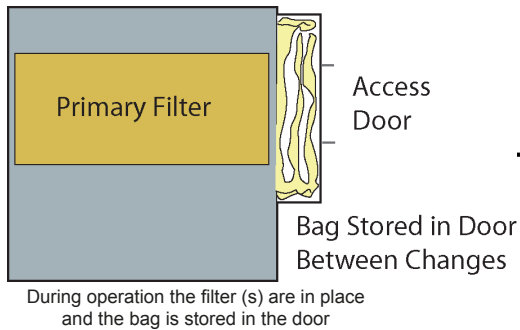

STEP 2

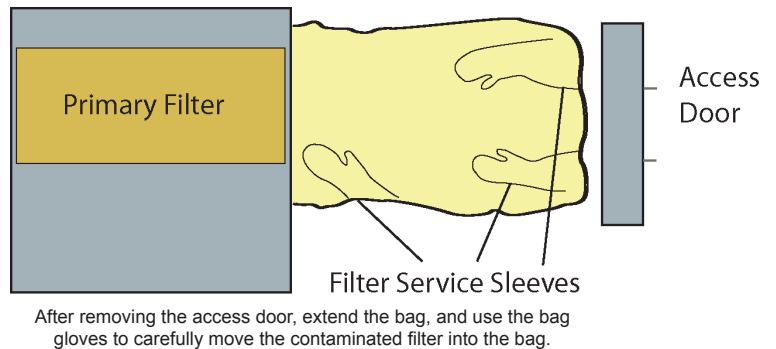

STEP 3

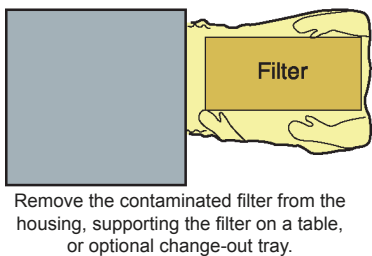

STEP 4

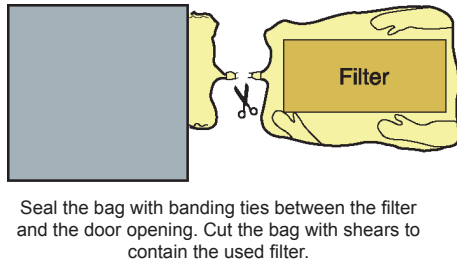

STEP 5

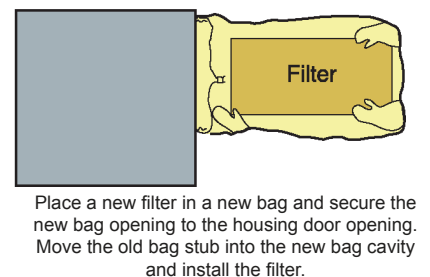

STEP 6

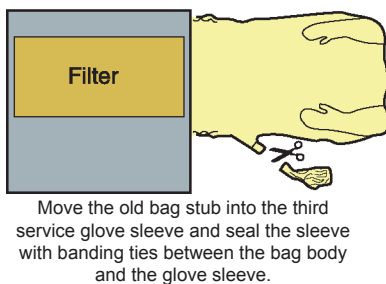

STEP 7

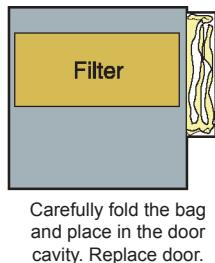

Bagging Flange Detail

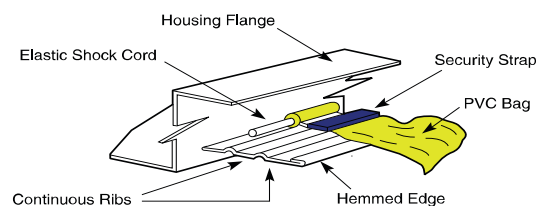

The illustration above portrays how the bag is placed over the ribs and held in place there by an elastic shock cord and security strap.

CF-3X3-012 P-1GB-SS

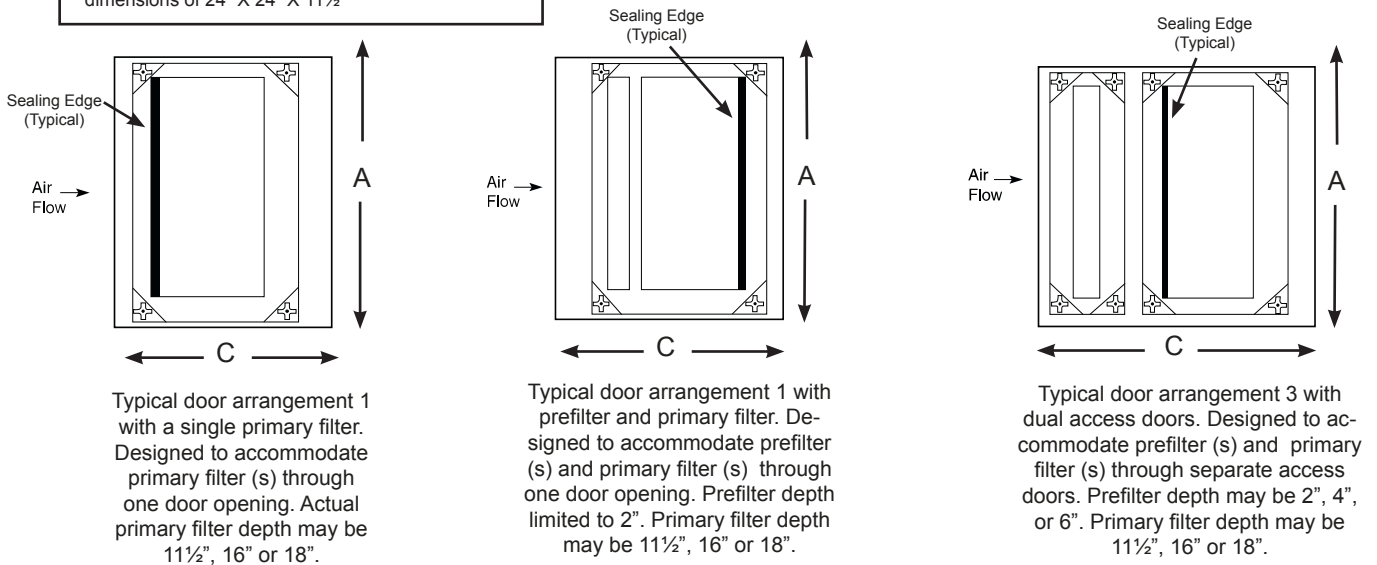
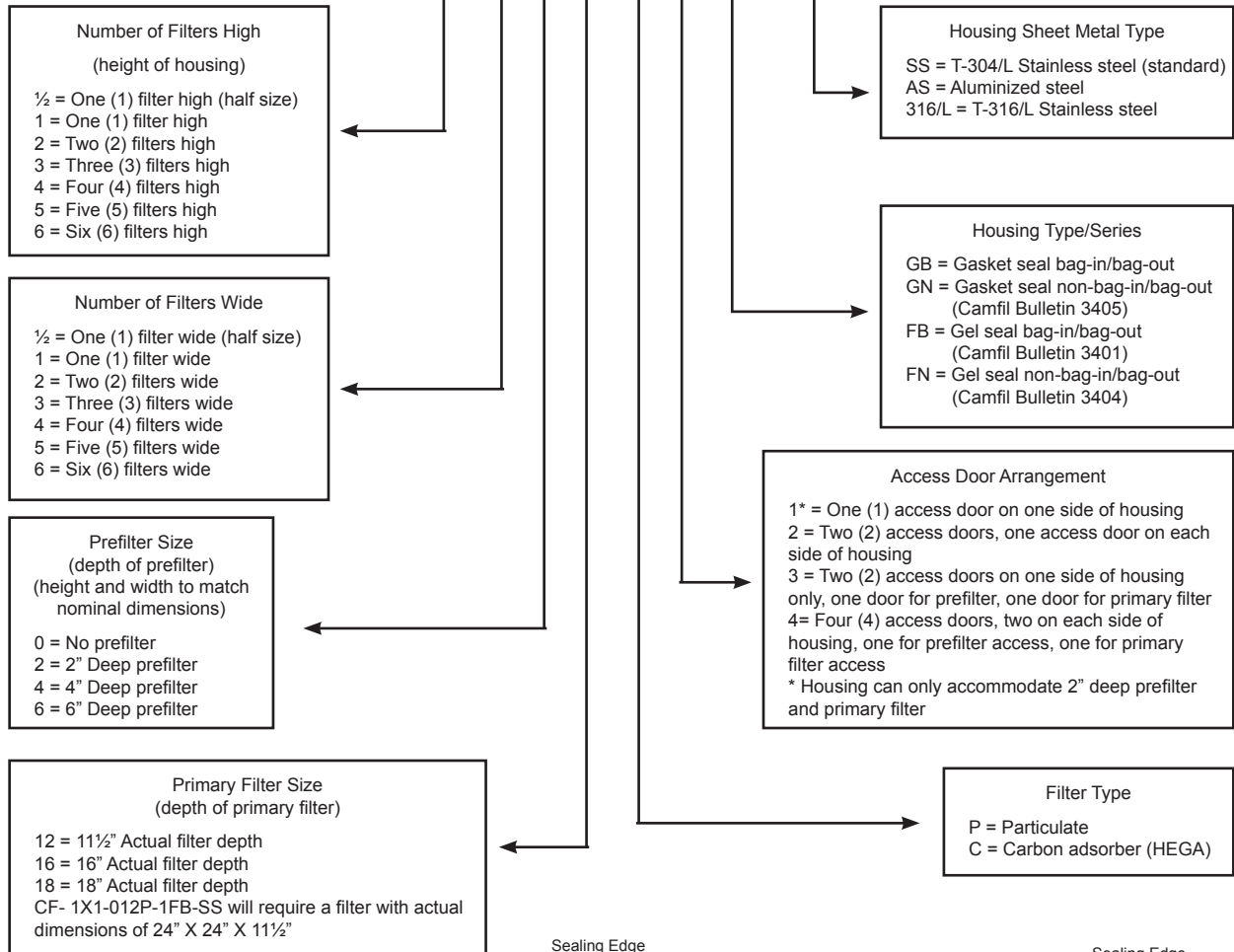

Housing Dimension A = Height B = Width C = Depth

Above arrangements show upstream, downstream and upstream primary filter seals respectively. Arrangement 1 is also available with downstream primary filter seal when in-place scan testing is required.

CamContain GB Housing

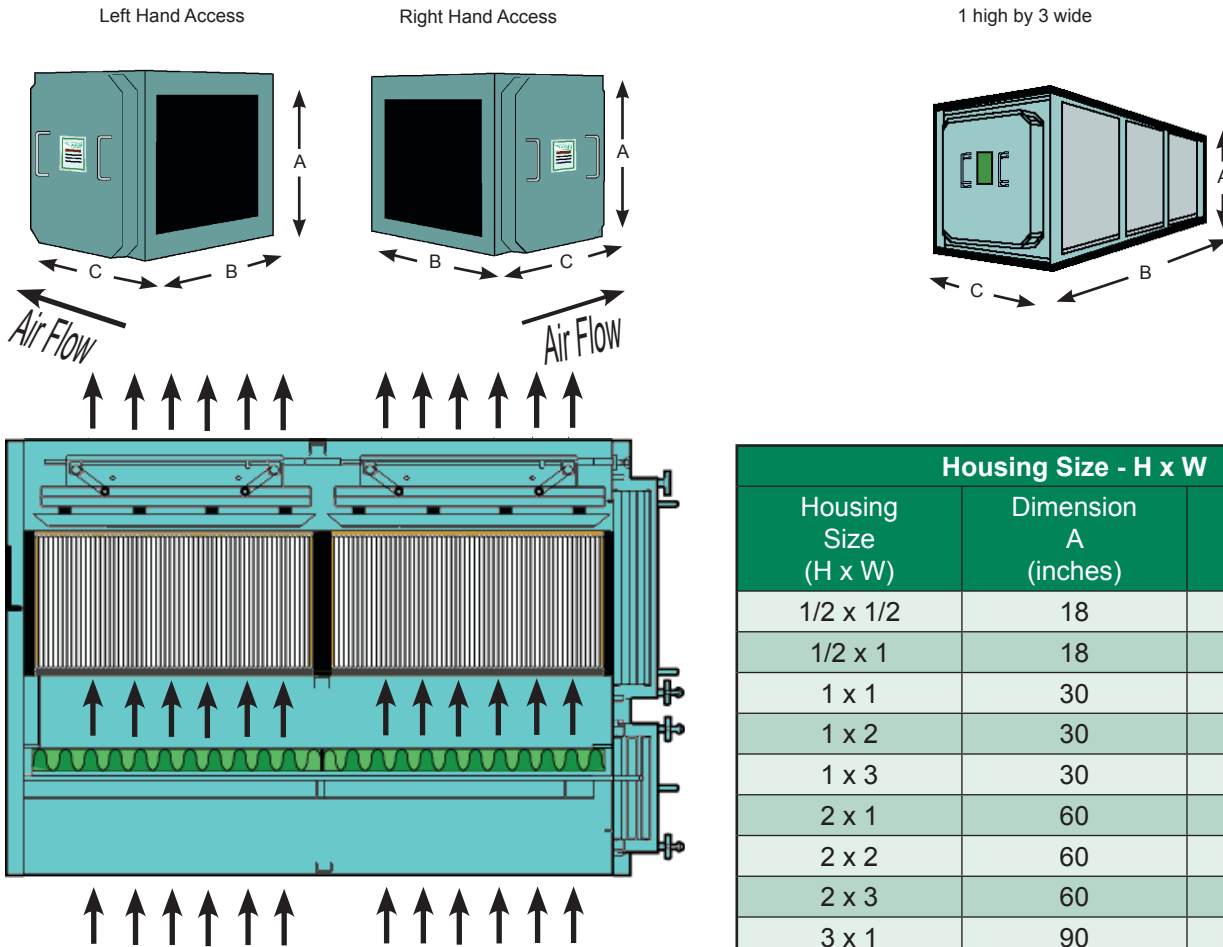

Camfil housings feature smooth surface construction. Pocket areas, that would allow contaminant build-up are minimized. All pressure retaining joints on the interior of the housing are continuously welded.

For detailed specifications or drawing, please consult your local Camfil Distributor or Representative or download from the Containment Toolbox located in the **Segments Tab** of **CamTab File Archive** at www.camfil.us.

Camfil has a policy of uninterrupted research, development and product improvement. We reserve the right to change designs and specifications without notice.

For assistance specific to this product, please contact Camfil Washington, NC facility at Sales-WA@camfil.com or by telephone at 877-658-6588.

| Housing Size - H x W | | |
|----------------------|----------------------|----------------------|
| Housing Size (H x W) | Dimension A (inches) | Dimension B (inches) |
| 1/2 x 1/2 | 18 | 15 |
| 1/2 x 1 | 18 | 27 |
| 1 x 1 | 30 | 27 |
| 1 x 2 | 30 | 51 |
| 1 x 3 | 30 | 75 |
| 2 x 1 | 60 | 27 |
| 2 x 2 | 60 | 51 |
| 2 x 3 | 60 | 75 |
| 3 x 1 | 90 | 27 |
| 3 x 2 | 90 | 51 |
| 3 x 3 | 90 | 75 |
| 4 x 1 | 120 | 27 |
| 4 x 2 | 120 | 51 |
| 4 x 3 | 120 | 75 |

| Housing Size - Depth | |
|----------------------|----------------------|
| Model Number | Dimension C (inches) |
| 012-1GB | 26 |
| 016-1GB | 30 |
| 018-1GB | 33 |
| 212-1GB | 30 |
| 216-1GB | 34 |
| 218-1GB | 36 |
| 212-3GB | 38 |
| 216-3GB | 42 |
| 218-3GB | 44 |

