

Air Moving Equipment



SHELDONS ENGINEERING



AIR HANDLING FANS

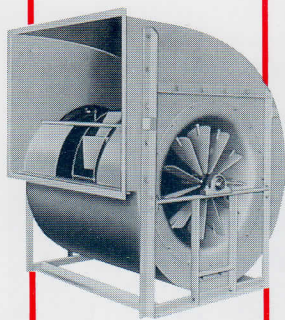

SERIES: 8000 - ULTRAFOIL AIRFOIL SWSI & DWDI
 SIZES: 18 $\frac{1}{4}$ " - 80 $\frac{3}{4}$ " Wheel Diameter
 CLASS: I, II, III, IV
 PERFORMANCE: Over 100,000 CFM to 16" SP.
 APPLICATION: Airfoil fans are non-overloading high efficiency type designed for general ventilation, air conditioning systems and high pressure processes where clean air is common.

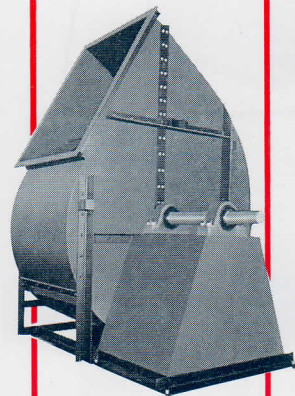

SERIES: 3000 - UNIFOIL BACKWARDLY INCLINED, SWSI & DWDI
 SIZES: 12 $\frac{1}{4}$ " - 80 $\frac{3}{4}$ " Wheel Diameter
 CLASS: I, II, III, IV
 PERFORMANCE: Over 100,000 CFM to 14" SP.
 APPLICATION: The B.I. fans are also non-overloading, designed for applications similar as airfoil, but more suitable for higher temperature and humid applications.

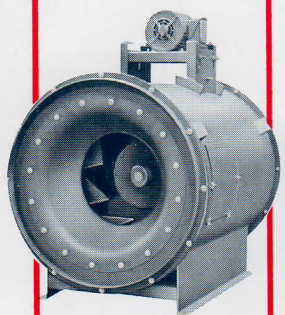

SERIES: 7000 TUBULAR CENTRIFUGAL, INLINE
 SIZES: 12 $\frac{1}{4}$ " - 60" Wheel Diameter
 CLASS: I, II, III
 PERFORMANCE: Up to 167,000 CFM to 12" SP.
 APPLICATION: This fan design is an airfoil for quieter operation for supply and exhaust, where space is limited.

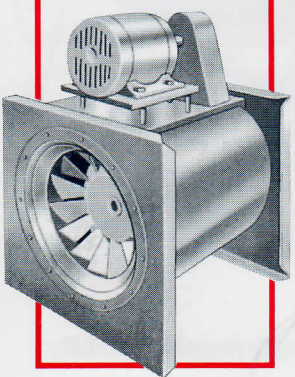

SERIES: 2000 TUBULAR MIXED FLOW, INLINE
 SIZES: 300 - 1200
 PERFORMANCE: Up to 40,000 CFM to 5" SP.
 APPLICATION: The Mixed Flow wheel provides for a compact design in air conditioning applications where sound levels are super critical.

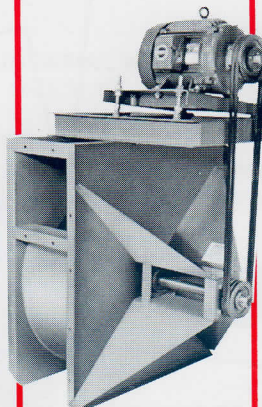

SERIES: 6000 SQUARE, FOUR POSITION AIRFOIL, SWSI and BACKWARD INCLINED, SWSI
 SIZES: 12 $\frac{1}{4}$ " - 49" Wheel Diameter
 CLASS: I, II, III
 PERFORMANCE: Over 100,000 CFM to 14" SP.
 APPLICATION: These fans are also non-overloading designed for applications more suitable for higher temperature and industrial applications.

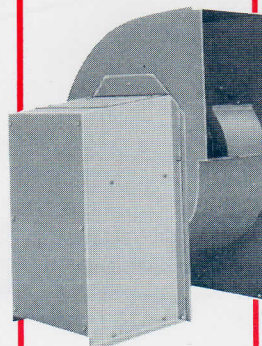

SERIES: 1000 AIRFOIL, FORWARD INCLINED and BACKWARD INCLINED, SWSI
 SIZES: 12 $\frac{1}{4}$ " - 36 $\frac{1}{2}$ " Wheel Diameter
 CLASS: I, II
 PERFORMANCE: Up to 30,000 CFM and 8" SP.
 APPLICATION: This fan design is for exhaust and supply air in hospitals, hotels, schools, restaurants, fume hoods, etc. Weather covers are available for protection of motor and drives for outdoor applications.

HIGH PRESSURE AIR HANDLING FANS

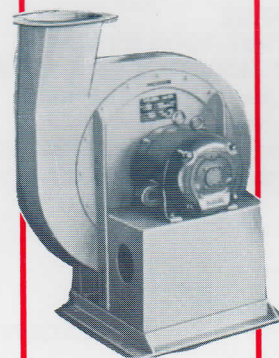

SERIES: 5000 RADIAL BLADE
 SIZES: 14" - 26" Wheel Diameter
 PERFORMANCE: Up to 5,000 CFM to 60" SP.
 APPLICATION: Most frequently supplied in Arrangement 4 direct drive and used for combustion air, glass cooling, cupolas, pneumatic conveying, gas boosting and a host of process applications.

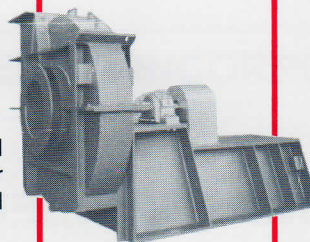

SERIES: 5900 RADIAL BLADE
 SIZES: 19 $\frac{1}{4}$ " - 71 $\frac{1}{4}$ " Wheel Diameter
 CLASS: V Maximum
 PERFORMANCE: Over 90,000 CFM to 70" SP.
 APPLICATION: These High Pressure fans are designed to handle moderate volumes of air at high pressures.

MATERIAL HANDLING FANS

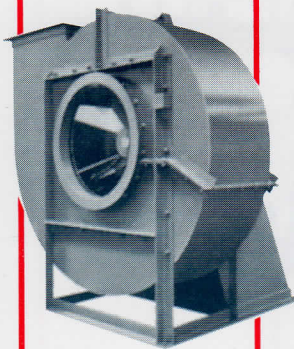

SERIES: 9000
RADIAL BLADE
SIZES: 12 $\frac{1}{4}$ " - 85 $\frac{1}{4}$ " Wheel Diameter
CLASS: I, II, III, IV
PERFORMANCE: Over 90,000 CFM to 40" SP.
APPLICATION: These heavy duty, easy to maintain industrial fans are available in four different wheel configurations, each designed for a special material handling application from coarse, sticky materials to lab exhaust fumes.

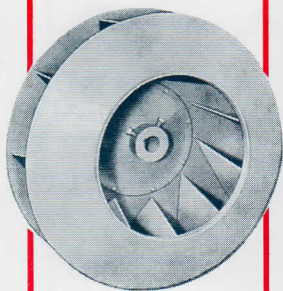

9000
THE "XB" WHEEL has the highest efficiency of the four types shown. It is designed to handle air only or air containing fumes with a small quantity of fine dust. It is not recommended for handling coarse materials when they must pass through the fan. This wheel is utilized on applications such as hot gas, general supply or exhaust fan in many industrial processes and may also be used as an induced draft fan in power plants.

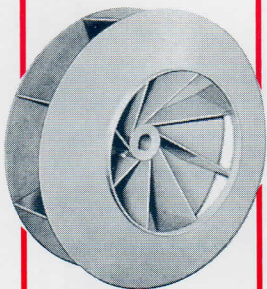

9100
THE "XS" WHEEL is used where the air contains granular material which passes directly through the fan. The radial-type blades are more wear-resistant than those of the XB wheel. It is widely used in conveying systems for sawdust, chips, grain etc., with static pressures up to 16" in the standard design.

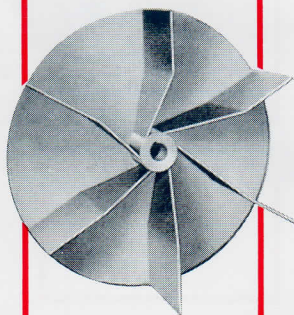

9200
THE "XC" WHEEL is a modification of the XS with the same number of blades with with no shroud. It is used primarily as an exhauster handling stringy materials such as long shavings, rags etc., which may be fed directly into the fan inlet.

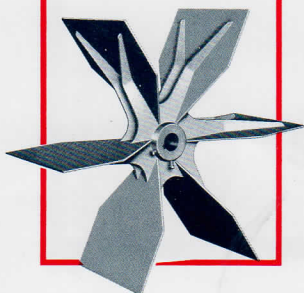

9300
THE "XO" WHEEL is another type of radial-bladed exhauster. The spider-type construction is designed for extremely rugged service, handling air containing knots, blocks, paper trim, silage or other heavy and bulky materials. This wheel is sometimes used as a "chopper" for fibrous material such as silage and paper trim as it is fed into the fan; in this application it is called a XO-CT wheel.

CUSTOM DESIGN FANS

FANS WITH INLET BODIES

INSULATED FANS FOR HIGH TEMPERATURE APPLICATIONS

FANS WITH INDEPENDENT BEARING PEDESTALS

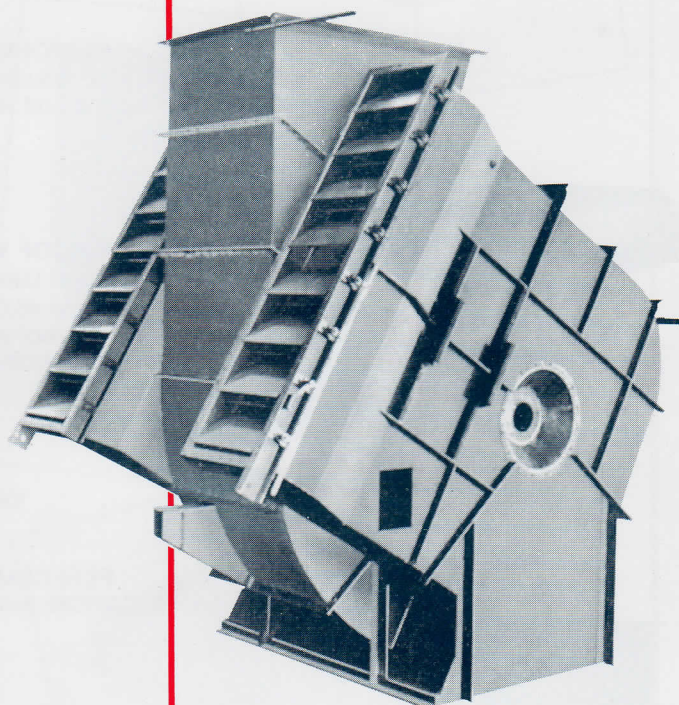

FANS CONSTRUCTED WITH SPECIAL MATERIALS: HASTALLOY, INCONEL, CORTEN, FERRALIUM AND STAINLESS STEEL

REPAIR AND REPLACEMENT

SHELDON'S ENGINEERING is equipped to make necessary components for rebuilding of its own and other manufacturer's fans. The service is available only for in-house rebuilding. Replacement parts are available on request.

AXIAL FANS

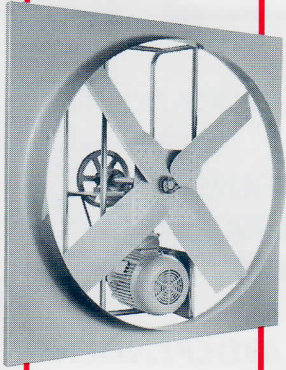

SERIES: 9400
VANEAXIAL AND TUBEAXIAL WITH STEEL WHEELS
SIZES: 12" - 120" Wheel Diameter
CLASS I, II and III
PERFORMANCE: Up to 325,000 CFM and 5" SP.
APPLICATION: Used in high temperature and corrosive environments.

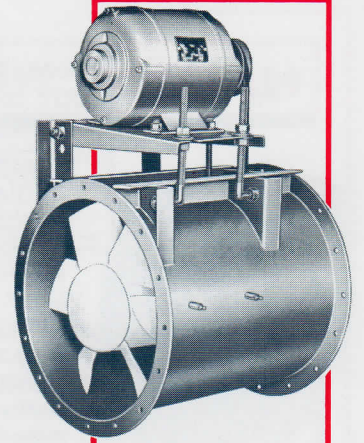

SERIES: 4500
PROPELLER FAN
SIZES: 12" - 72" Wheel Diameter
PERFORMANCE: Over 84,000 CFM to 1½" SP.
APPLICATION: Used in low pressure, high volume air moving applications such as circulation and ventilation through a wall without ductwork.

SERIES: 9600
VANEAXIAL AND TUBEAXIAL WITH ALUMINUM WHEELS
SIZES: 15" - 72" Wheel Diameter
CLASS I and II
PERFORMANCE: Up to 180,000 CFM and 11" SP.
APPLICATION: Industrial processes, textile industry, air conditioning, heating and ventilation applications, pressurizing and wind tunnels.

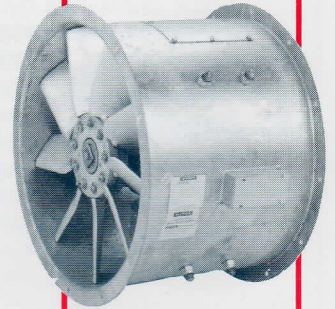

SERIES: 4600
HOODED POWER ROOF VENTILATOR
SIZES: 12" - 60" Wheel Diameter
PERFORMANCE: Up to 46,000 CFM at ½" SP.
APPLICATION: These roof ventilators are ideal for clean air, low velocity applications in both supply and exhaust service.

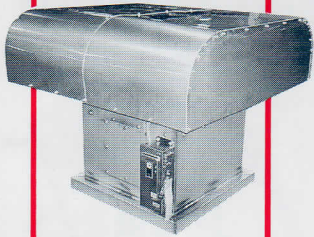

SERIES: 9700
POWER ROOF VENTILATOR
VANEAXIAL AND TUBEAXIAL WHEELS
SIZES: 12" - 72" Wheel Diameter
CLASS I, II and III
PERFORMANCE: Up to 180,000 CFM and 11" SP.
APPLICATION: Industrial and automotive exhaust systems.

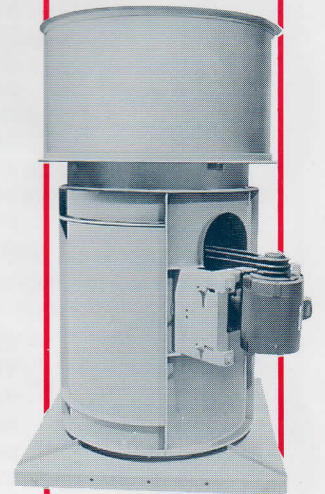

SERIES: 4700
LOW PROFILE POWER ROOF VENTILATOR
SIZES: 12" - 60" Wheel Diameter
PERFORMANCE: Up to 46,000 CFM at ½" SP.
APPLICATION: The LPRV is an economical, compact exhaust ventilator. Low profile roof ventilators are commonly used on warehouses, airports, schools and shopping centres.

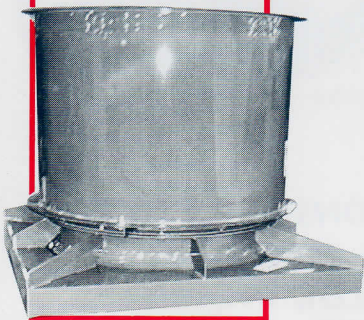

SHELDONS ENGINEERING INCORPORATED

6660 Ordan Drive,
Mississauga, Ontario
Canada L5T 1J7
www.sheldonsengineering.com
Phone (905) 564-5072
Fax (905) 564-9004